

S·phone

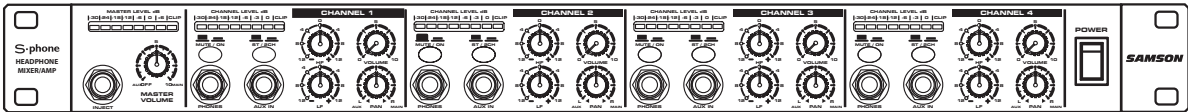

HEADPHONE MIXER/AMP

Owners Manual

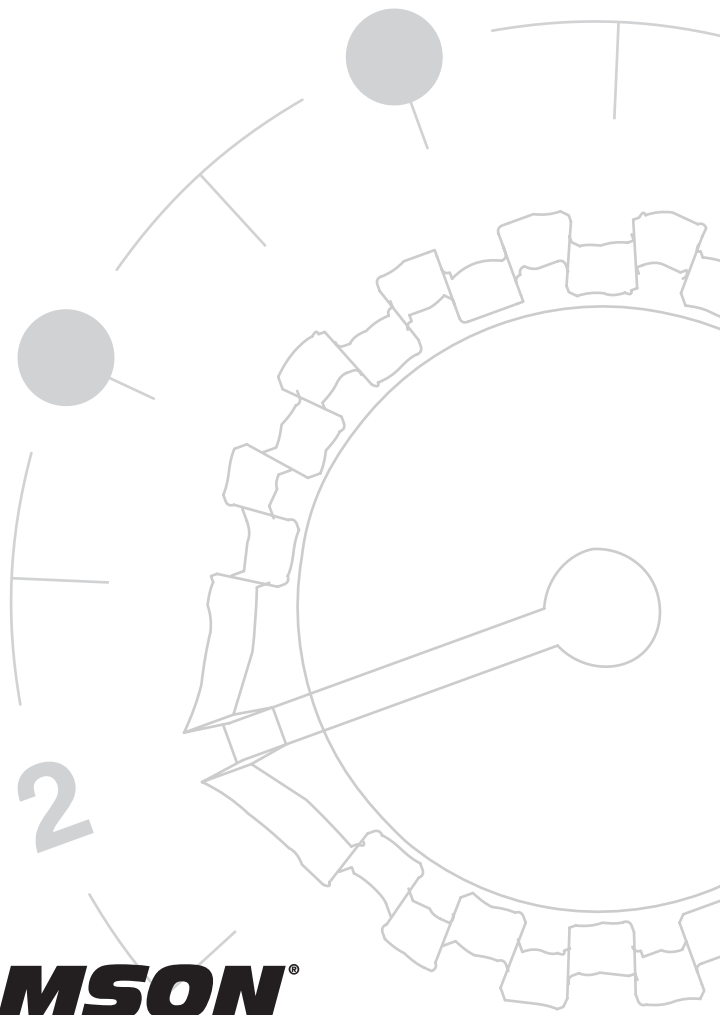

SAMSON®

Safety Instructions

Caution: To reduce the hazard of electrical shock, do not remove cover or back.

No user serviceable parts inside. Please refer all servicing to qualified personnel.



WARNING: To reduce the risk of fire or electric shock, do not expose this unit to rain or moisture.

The lightning flash with an arrowhead symbol within an equilateral triangle, is intended to alert the user to the presence of uninsulated "dangerous voltage" within the products enclosure that may be of sufficient magnitude to constitute a risk of electric shock to persons.

The exclamation point within an equilateral triangle is intended to alert the user to the presence of important operating and maintenance (servicing) instructions in the literature accompanying the product.

Important Safety Instructions

1. Please read all instructions before operating the unit.
2. Keep these instructions for future reference.
3. Please heed all safety warnings.
4. Follow manufacturers instructions.
5. Do not use this unit near water or moisture.
6. Clean only with a damp cloth.
7. Do not block any of the ventilation openings. Install in accordance with the manufacturers instructions.
8. Do not install near any heat sources such as radiators, heat registers, stoves, or other apparatus (including amplifiers) that produce heat.
9. Do not defeat the safety purpose of the polarized or grounding-type plug. A polarized plug has two blades with one wider than the other. A grounding type plug has two blades and a third grounding prong. The wide blade or third prong is provided for your safety. When the provided plug does not fit your outlet, consult an electrician for replacement of the obsolete outlet.
10. Protect the power cord from being walked on and pinched particularly at plugs, convenience receptacles and at the point at which they exit from the unit.
11. Unplug this unit during lightning storms or when unused for long periods of time.
12. Refer all servicing to qualified personnel. Servicing is required when the unit has been damaged in any way, such as power supply cord or plug damage, or if liquid has been spilled or objects have fallen into the unit, the unit has been exposed to rain or moisture, does not operate normally, or has been dropped.

Table of Contents

Introduction	2
S•phone Features	3
Controls and Functions	
Front Panel Layout	
Rear Panel Layout	4-5
Operating the S•phone	
Setting Up the S•phone	6-7
S•phone Master section	7
S•phone Channels	8
Stereo and Two Channel Modes	9
S•phone Connections	
Cue Mix Set-up for Multitrack Vocal Recording	10
Cue Mix Set-up for Multitrack Rhythm section Recording	11
Linking Multiple S•phones	12
Headphone Impedance and Sensitivity ratings	13
S•phone Wiring Guide	14
Specifications	15-16
Block Diagram	17

Copyright 2001, Samson Technologies Corp.

Printed May, 2001

Samson Technologies Corp.
575 Underhill Blvd.
P.O. Box 9031
Syosset, NY 11791-9031
Phone: 1-800-3-SAMSON (1-800-372-6766)
Fax: 516-364-3888
www.samsontech.com

Introduction

Congratulations on purchasing the Samson S•phone Headphone Amplifier! Although this unit is designed for easy operation, we suggest you take some time out first to go through these pages so you can fully understand how we've implemented a number of unique features. The S•phone is a compact, high-quality device that allows you to monitor any stereo or monophonic source signal (balanced or unbalanced) over as many as twelve separate headphones. Providing unusually high power levels and superb audio fidelity, the S•phone is compatible with virtually all popular headphone models. Front panel controls include a Master Input Level control and Stereo/2 Channel switch. Each headphone output has its own individual HIGH & LOW Frequency EQ, an Insert jack, and Level control. Special output jacks on the rear panel allows any number of S•phone units to be linked together with no loss of signal. The S•phone can be used in a wide variety of applications, including recording studios, teaching labs, broadcast environments, and for live performance. In this manual, you'll find a more detailed description of the features of the S•phone, as well as a guided tour through the front and rear panels, step-by-step instructions for using the S•phone, a reference chart that gives impedance and sensitivity ratings for a number of popular headphone models, and full specifications. You'll also find a warranty card enclosed—please don't forget to fill it out and mail it so that you can receive online technical support and so we can send you updated information about other Samson products in the future.

With proper care and adequate air circulation, your S•phone will operate trouble free for many years. We recommend you record your serial number in the space provided below for future reference.

Serial number: _____

Date of purchase: _____

Should your unit ever require servicing, a Return Authorization number (RA) must be obtained before shipping your unit to Samson. Without this number, the unit will not be accepted. Please call Samson at 1-800-3SAMSON (1-800-372-6766) for a Return Authorization number prior to shipping your unit. Please retain the original packing materials and if possible, return the unit in the original carton and packing materials.

S•phone Features

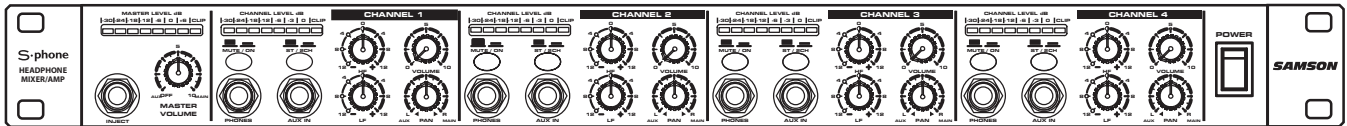

The Samson S•phone headphone amplifier utilizes the latest technology in gain management design. Here are some of its features:

- Four channel headphone mixer amplifier.
- Three headphone outputs; two rear, plus one front panel output per channel.
- Two master stereo inputs with balance control.
- Dual band equalizer on each channel.
- 5 segment LED meter on each channel plus master.
- Auxiliary input, with level control, on each channel for "More Me" mixing.
- Stereo or dual input mode and mute switches on each channel.
- Maximum output power on each channel regardless of headphone impedance.
- Three year extended warranty.

Controls and Functions

FRONT PANEL LAYOUT

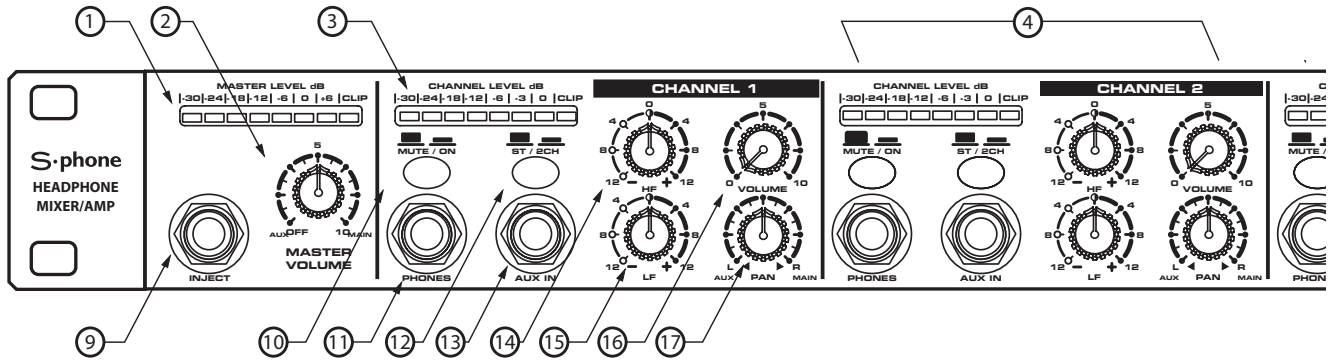

- ① **MASTER LEVEL METER** - Indicates the amount of signal being driven into the four channels from the master volume control.
- ② **MASTER VOLUME** - Controls the level being sent to the individual channels.
- ③ **CHANNEL LEVEL METER** - Displays the amount of power being supplied to the channels.
- ④ **HEADPHONE CHANNEL 2** - The same knob and switch compliment as Channel 1 is duplicated for Channel 2.
- ⑤ **HEADPHONE CHANNEL 3** - The same knob and switch compliment is duplicated for Channel 3.
- ⑥ **HEADPHONE CHANNEL 4** - The same knob and switch compliment is duplicated for Channel 4.
- ⑦ **MAIN POWER SWITCH** - When turned on, activates the S-phone.
- ⑧ **RACK EARS** - Used for mounting into a standard 19 inch rack.
- ⑨ **MASTER INJECT** - Stereo TRS front panel input for injecting a signal into the main mix.
- ⑩ **MUTE SWITCH** - Used for muting the signal on the individual channels.

REAR PANEL LAYOUT

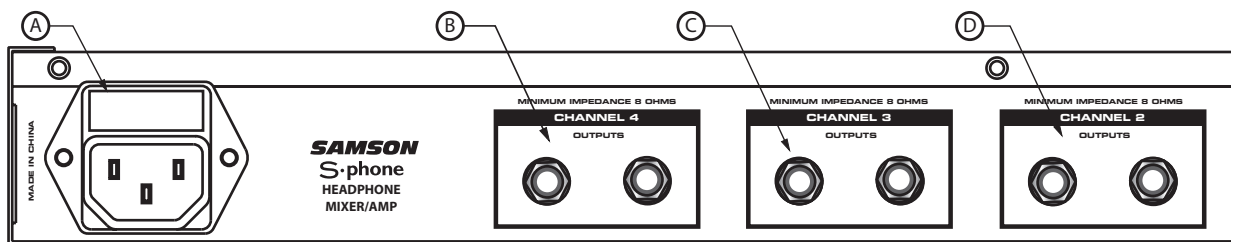

- Ⓐ **AC INLET** - IEC standard AC power cable connector with external fuse.
- Ⓑ **CHANNEL 4 OUTPUTS** - 2 rear panel headphone outputs for Channel 4.
- Ⓒ **CHANNEL 3 OUTPUTS** - 2 rear panel headphone outputs for Channel 3.
- Ⓓ **CHANNEL 2 OUTPUTS** - 2 rear panel headphone outputs for Channel 2.

Controls and Functions

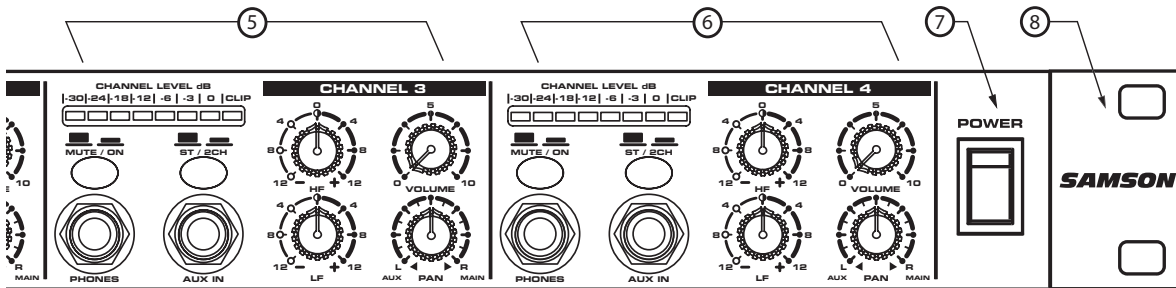

- ⑪ **HEADPHONE OUTPUT** - A front panel headphone output for each channel.
- ⑫ **ST/2CH SWITCH** - Switches between stereo and 2 channel modes.
- ⑬ **AUX IN** - Used to inject a "MORE ME" signal into the individual amp channels.
- ⑭ **HIGH FREQUENCY EQ** - Controls the amount of high frequency EQ applied to headphone output.
- ⑮ **LOW FREQUENCY EQ** - Controls the amount of low frequency EQ applied to headphone output.
- ⑯ **VOLUME CONTROL** - Controls the volume to the headphone output for the individual channel.
- ⑰ **PAN CONTROL** - Controls the balance from left to right in stereo mode and from aux to main mode.

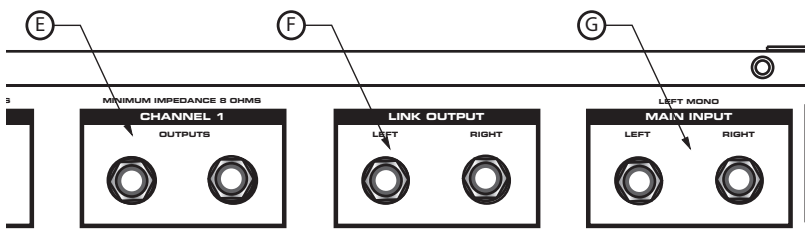

- ⑤ **CHANNEL 1 OUTPUTS** - 2 rear panel headphone outputs for Channel 1.
- ⑥ **LINK OUTPUTS** - Outputs that are tied to the main input for linking to another headphone amp or other device.
- ⑦ **MAIN INPUT** - The main signal input to the headphone amp. Plugging into the left jack only sends the signal to both the left and right.

Operating the S•phone

SETTING UP THE S•phone

Setting up your S•phone Headphone Amplifier is a simple procedure, which takes only a few minutes.

Remove all packing materials (save them in case of need for future service) and plug the provided AC power cord in the rear AC inlet, but don't plug the power cable into a wall outlet just yet.

- Connect the output from the device you want monitored to the Left/Right MAIN INPUT jacks on the S•phone rear panel. The S•phone accepts both balanced and unbalanced signal. Generally, a balanced signal is preferable because it provides better signal-to-noise ratio and reduced extraneous noise.
- Set the controls to the following positions:

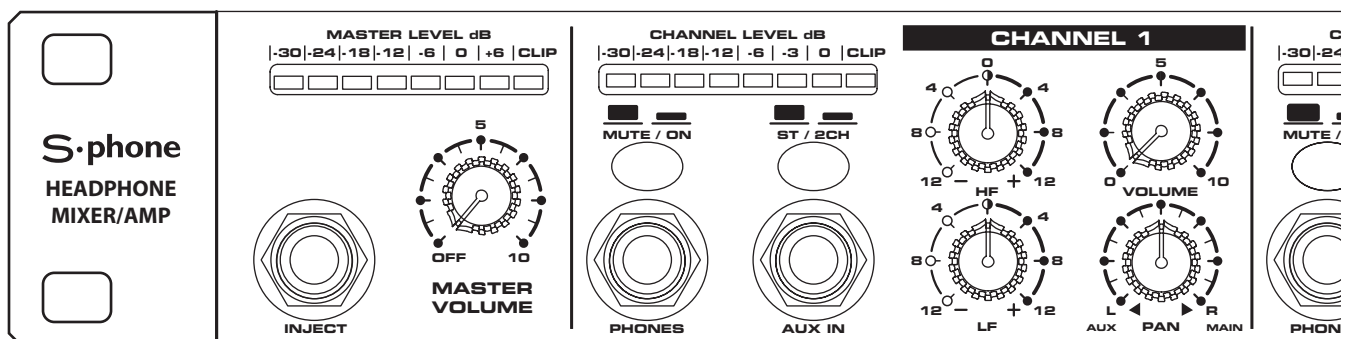

MASTER VOLUME – OFF

CHANNEL 1 MUTE SWITCH – OUT

CHANNEL 1 ST/2CH SWITCH – OUT

CHANNEL 1 HIGH FREQUENCY – 0

CHANNEL 1 LOW FREQUENCY – 0

CHANNEL 1 PAN – CENTER, 12:00

CHANNEL 1 VOLUME – 0

CHANNEL 2 - 4's Controls - Set the Same as Channel 1

- Turn the Master Volume knob and all four headphone Channel Output knobs to their minimum (fully counterclockwise) setting.
- Plug the S•phone power cable into a wall outlet and switch the unit on by pressing the power switch.
- Apply a signal, like the output of a mixer playing a CD, to the S•Phone's rear-panel Left/Right MAIN INPUT jacks. Raise the MASTER VOLUME until the meter reaches -18 to -12 dB.
- Connect a set of headphones to Channel 1 and slowly turn the channel's Volume knob clockwise until you hear the desired level.

WARNING: Because the S•Phone is capable of generating extremely high volume levels, always start with the Channel Volume knob at minimum and then slowly turn it up.

Operating the S•phone

SETTING UP THE S•phone - Continued

- Repeat the previous step for all Channels that have headphones connected, making sure to start the VOLUME knob completely counterclockwise and then slowly raising it until the desired level is achieved. If you have connected different models of headphones to the various Channel Headphone jacks, you may find that some require more gain than others to achieve the same volume. This kind of disparity will occur if the various headphones have different impedances. The lower the impedance, the louder the headphone will sound compared to another, higher impedance headphone at the same VOLUME setting. Another factor affecting headphone loudness is called sensitivity. This is generally measured by determining the decibel (dB) level generated by 1 mW of power input. The higher the dB rating, the louder the headphone. See the Reference chart on page 16 of this manual for more details.
- To achieve optimum signal-to-noise ratio, the MASTER VOLUME should generally be set as high as possible, short of audible distortion. However, if this results in your getting blasted with signal even though the channel volume is near minimum, you'll need to decrease the Master Volume while raising one or more channel volume levels. Conversely, if you find that you have to raise one or more headphone Channel Volume knobs to maximum or near maximum to achieve the desired level, try increasing the Master Volume Level while decreasing the channel volume(s).

S • Phone Master Section

① Master Volume

The S•phone's MASTER VOLUME control is used to adjust the input signal connected to the MAIN Left and Right inputs. In addition, the MASTER VOLUME control adjusts the level of the signal inserted in the MASTER INJECT, which is summed with the MAIN Left and Right input signal.

② Master Level meter

The S•phone's master section includes an 8 segment LED LEVEL meter which monitors the input level of the MAIN Left and Right Inputs in Decibels (dBs) from -30 to CLIP. If the LEVEL meter displays a CLIP signal, then turn down the signal being sent into the MAIN left and Right.

③ Using the Master Inject

The S•phone's MASTER INJECT is a TRS input (Tip, Ring, Sleeve) that allows a second stereo signal to be inserted and summed together with the MAIN Left and Right signals. You can use a stereo signal from your mixers buss outputs or auxiliary sends to balance the mix between two stereo signals like rhythm tracks and vocals.

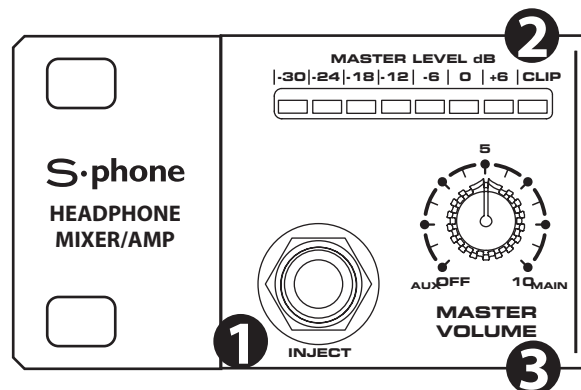

Operating the S•phone

S • PHONE CHANNELS

① Headphone Output

The S•phone's Headphone Output jack accepts a standard 1/4" TRS connector for easy interface with most professional headphones. Once the MASTER VOLUME has been set, the channels output level is set by the VOLUME knob.

② Channel MUTE Switch

The S•phone features Mutes Switches on each of the four channels. When engaged, the LED illuminates and indicates that the channel output is turned off.

③ ST/2-CH Stereo Two Channel Switch

Each of the S•phone's four channels can be set to operate in two modes: Stereo and Two-Channel. In stereo, mode all signals inserted into the signal path including the MAIN, MASTER INJECT and Channel AUX input, maintain their stereo image. In 2-Channel mode, the signals are all summed to mono and the PAN control now becomes the balance between the MAIN stereo mix and the AUX input. More info on 2-Channel mode on page 11 of this manual.

④ AUX Input

Each of the S phones four Channels features an AUX input for inserting a signal directly into that channels headphone amp. The AUX input is particularly useful for adding a solo instrument or vocal send. In this case, the AUX input is mixed with the MAIN mix so that listeners on that channel can have their own balance between the MAIN mix and their instrument or vocal. This is commonly known as "More-Me" cue mixing. Depending on the status of the STEREO/2-CHANNEL switch, the AUX level is adjusted at the signal source, like the aux send from a mixer, or by using the PAN control.

⑤ Using the Channel EQ

Each of the four S•phone channels feature a two-band equalizer allowing individual tone settings on each channel. The LOW Frequency EQ control provides up to 12 dB of CUT or BOOST at 100Hz. You'll notice a single detent when the control knob is located in the center of its travel range indicating that there is no boost or cut and that the LOW frequency response of the channel is flat. The HIGH Frequency EQ control provides up to 12 dB of CUT or BOOST at 10kHz. You'll notice a single detent when the control knob is located in the center of its travel range indicating that there is no boost or cut and that the HIGH frequency response of the channel is flat.

⑥ PAN Control

Each of the S•phone's four channels has a PAN control which controls how much signal is sent to the left or right headphone output. The control knob has a center detent which indicates that the left and right sides are balanced. In 2 Channel mode, the signal becomes mono and the PAN knob adjusts the balance between the MAIN (plus MASTER INJECT mix) and the Channel AUX input. (For more information on 2 Channel mode, see the section "Mixing Signals in 2 Channel Mode" found on page 11 of this manual.)

⑦ VOLUME Control

The Channel VOLUME control is used to adjust the channel headphone output. The Volume control will adjust the level of the front panel headphone outputs, as well as, that channel's rear panel headphone outputs.

⑧ CHANNEL LEVEL Meter

Each S•phone Channel has an 8 segment LED LEVEL meter which monitors the output of the channel in Decibels (dBs) -30 to CLIP. If the LEVEL meter displays a CLIP signal, then turn down the Channel VOLUME, and if necessary, also turn down the MASTER VOLUME .

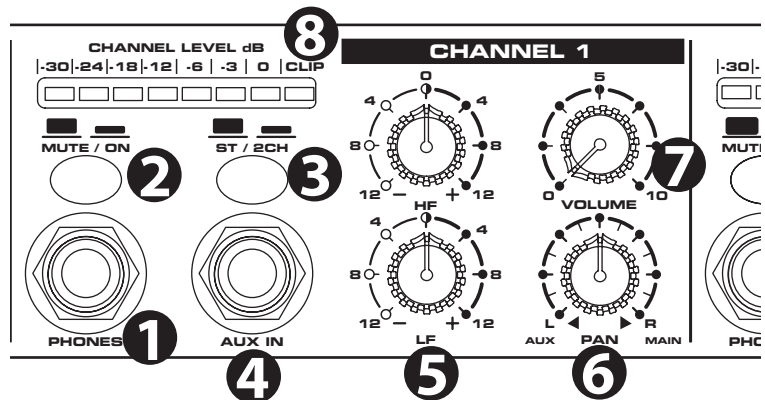

Operating the S•phone

STEREO AND TWO-CHANNEL MODES

Each of the S•phone's four channels can be set to operate in two different modes: Stereo and 2 Channel.

Stereo Mode

Stereo mode is a normal operating mode where all mix inputs including MAIN, MASTER INJECT, as well as the Channel AUX input, maintain their stereo image throughout the signal path to each headphone output. The individual Channel's PAN control is used to adjust the balance between the Left and Right side. To design a monitor mix in the Stereo mode, follow these steps:

- Press the ST/2CH switch to the OUT positions, you'll notice the switch LED is not illuminated indicating that Channel 1 is in STEREO mode.
- Make a Stereo connection from your mixer's auxiliary or buss outputs to the MAIN Left and Right inputs on the S•phone's rear panel.
- Make a Stereo connection from your mixer's auxiliary or buss outputs to the MASTER INJECT input on the S•phone's front panel.
- Make a Stereo connection from your mixer's auxiliary or buss outputs to the Channel 1 AUX input located on the S•phone's front panel.
- In the Stereo mode, you adjust the mix balance between the MAIN, MASTER INJECT mix and the Channel AUX input at your mixer by balancing the combinations of auxiliary and bus sends you have connected to the S•phone.

Mixing Signals in 2 Channel Mode

In 2 Channel mode, all mix inputs including MAIN, MASTER INJECT, as well as the Channel AUX input are summed to a mono signal. In this mode, the individual Channel's PAN control is used to adjust the balance between the MAIN(which includes the MASTER INJECT), and the channel AUX input. To design a monitor mix in the 2 Channel mode follow these steps:

- Press the ST/2CH switch to the IN positions, you'll notice the switch LED is now illuminated indicating that Channel 1 is in 2- Channel mode.
- Make a Stereo connection from your mixer's auxiliary or buss outputs to the MAIN Left and Right inputs on the S•phone's rear panel.
- If a second mix is desired, make a Stereo connection from your mixer's auxiliary or buss outputs to the MASTER INJECT located on the S•phone's front panel.
- Make a Stereo connection from your mixer's auxiliary or buss outputs to the Channel 1 AUX input located on the S•phone's front panel.
- In the 2-CH mode you adjust the mix balance between the MAIN, MASTER INJECT mix and the Channel AUX input at your mixer by balancing the combinations of auxiliary and bus sends you have connected to the S•phone.

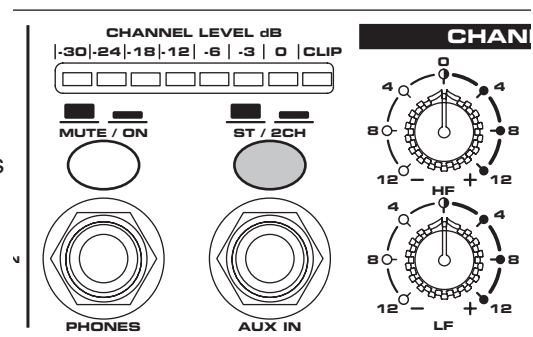

S•phone Connections

CUE MIX SET-UP FOR MULTITRACK VOCAL RECORDING

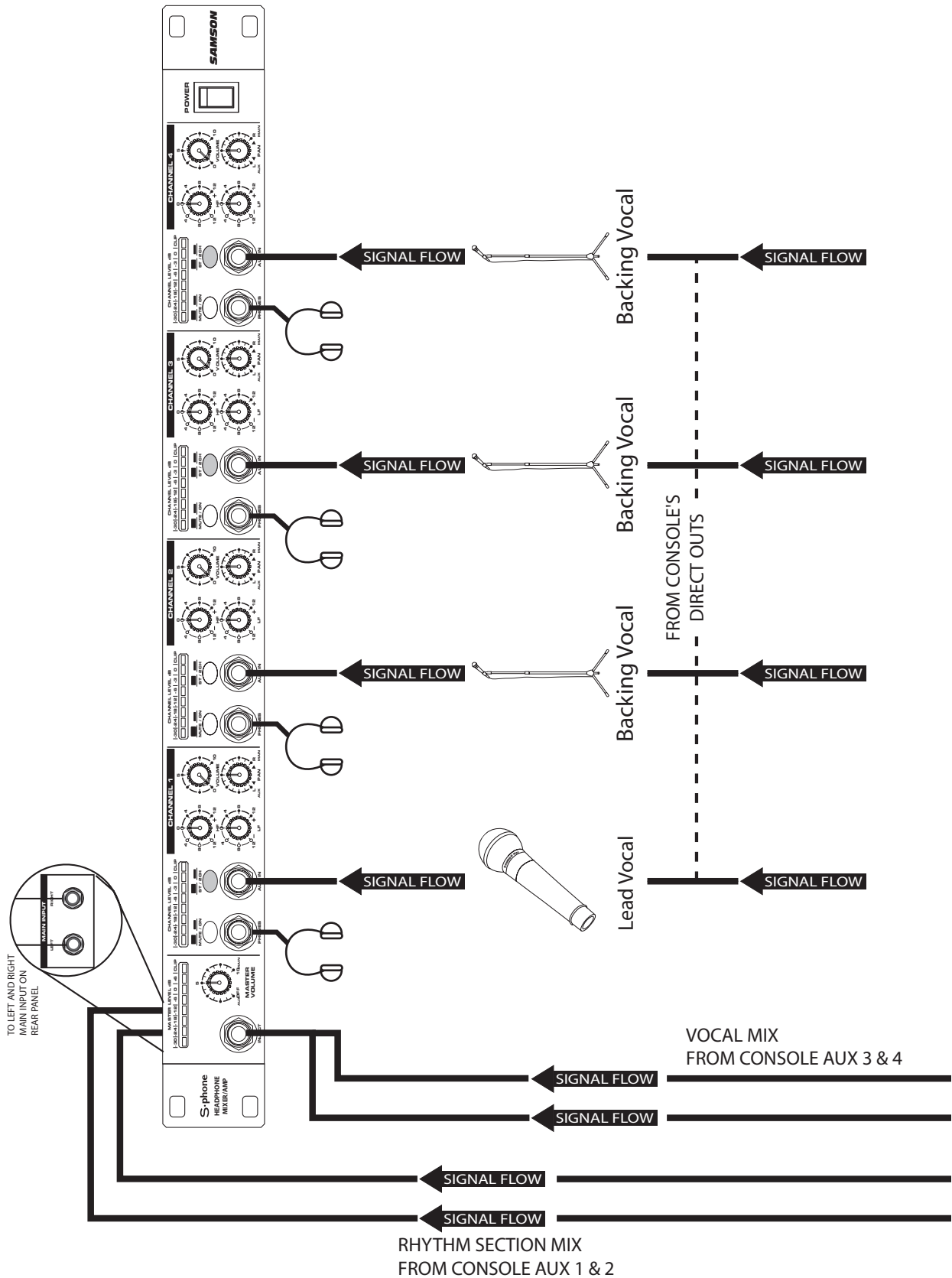

S•phone Connections

LINKING MULTIPLE S•phones

Any number of S•phones' can be linked together (daisy-chained), allowing you to monitor an input signal over more than twelve sets of headphones, or to give individual musicians more control over their own headphone mix. To do this, simply follow these basic steps:

- Make a connection between one S•phone's Left/Right Link outputs and the next one's Left/Right Main inputs.

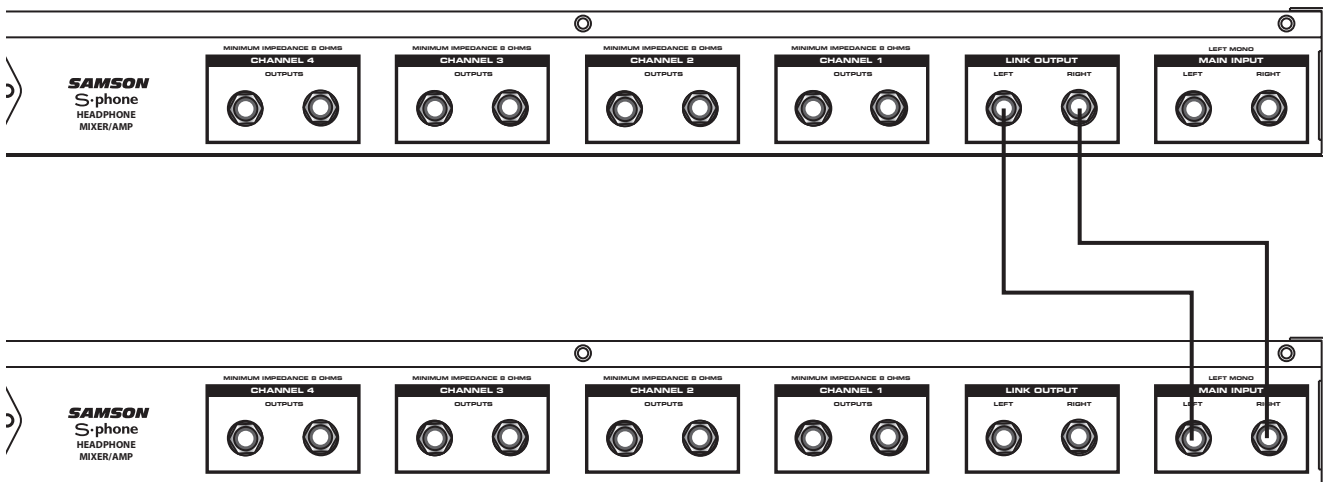

Because the S•phone Stereo Link output jacks are electronically balanced, we recommend the use of 3-conductor cable and 1/4" TRS (Tip/Ring/Sleeve) connectors. Even when several S•phones are linked together this way, there is no loss of power or audio fidelity—every Channel on every S•phone will sound just as loud and clear as if it were the only unit connected. The status of the front-panel Stereo/2 CH buttons affects only that unit and has no effect on any subsequent linked units.

S•phone Connections

Headphone Impedance and Sensitivity Ratings

Virtually all headphones that terminate in a stereo 1/4" plug can be used with the S•phone Headphone Amplifier. This chart provides a partial listing of some of the more popular models, along with their impedance and sensitivity ratings. As described on page 9 of this manual, headphones with lower impedances (or higher sensitivity) will sound louder as compared to other, higher impedance (or lower sensitivity) headphones at the same channel Volume setting. Samson Technologies has no connection with any of these manufacturers, nor do we endorse any particular models for use with the S•phone. This is simply a reference listing for your convenience. For more information about any of these headphones, contact the manufacturer directly.

SAMSON HEADPHONES

Model	Impedance	Sensitivity
PH60		
RH100		
RH300		
RH600		
CH70		
CH700		

OTHER MANUFACTURER'S HEADPHONES

Manufacturer	Model	Impedance	Sensitivity
AKG	K-141	600 ohm	98 dB
AKG	K-240	600 ohm	88 dB
Beyer	DT-150	250 ohm	114 dB
Beyer	DT-801	250 ohm	114 dB
Fostex	T-10	50 ohm	91 dB
Fostex	T-20	50 ohm	96 dB
Fostex	T-40	50 ohm	98 dB
Sennheiser	HD-450 (original)	70 ohm	94 dB
Sennheiser	HD-450 Series II	60 ohm	94 dB
Sony	MDR-7502	45 ohm	100 dB
Sony	MDR-7504	45 ohm	103 dB
Sony	MDR-7506	63 ohm	106 dB

S•phone Wiring Guide

Unbalanced 1/4" Connector

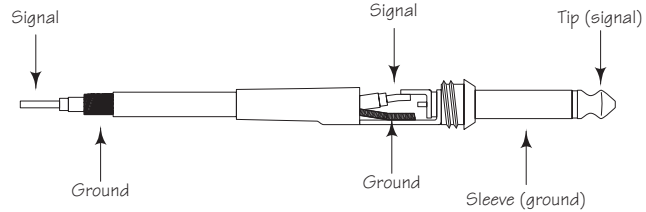

Balanced TRS 1/4" Connector

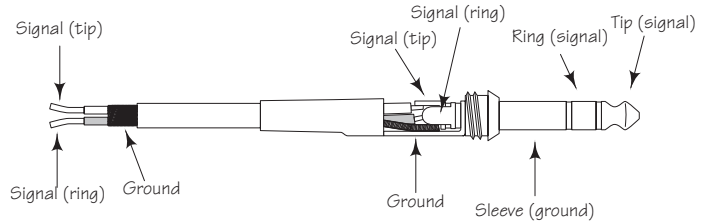

Insert Cable 1/4" TRS connector to two 1/4" can be used to connect a stereo signal to the Channel AUX or Master Inject.

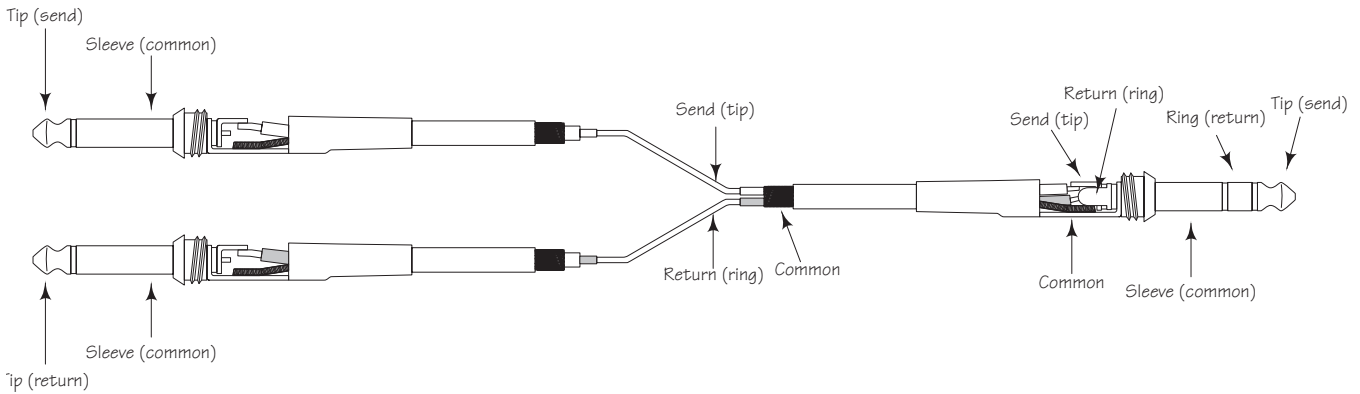

XLR Balanced Wiring Guide

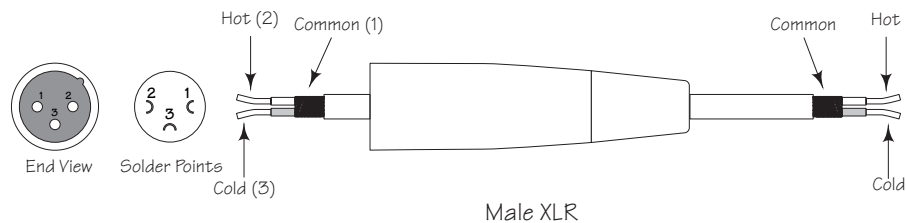
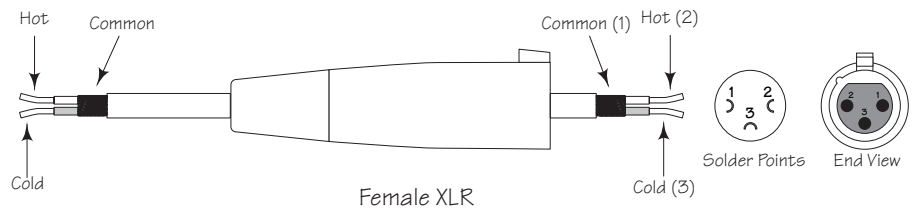

Specifications

Master Section (Rear Panel)

Input	2 TRS Balanced 1/4" (Left-Right) or (Left mono)
Impedance	15 k Ohms balanced
Max. input level	+26 dBu balanced
CMRR:	Min 40dB, >55 dB @ 1 kHz

Master Section (Front Panel)

Master Volume control	0 - 10
Master Level Meters	5 Segment LED (-30 to Clip)
Master Inject	1/4" TRS jack (Left-Right)

Link Output

Connectors	2-1/4" TRS Balanced (Left-Right) Parallel to Main Input
Max Output Level	Matches Main Input

Channels

AUX IN Connectors	1/4" TRS jack (Left-Right)
Impedance	10 k Ohms unbalanced
Max. input level	+21 dBu unbalanced
Level Meters	5 Segment LED (-30 to Clip) (load compensating)
Channel Controls	Mute Switch, ST/2CH Switch, Volume Control Balance Control
High Frequency EQ	+/- 12dB @ 10KHz Shelving
Low Frequency EQ	+/- 12dB @ 100Hz Shelving
Outputs	3 - 1/4" TRS (Left-Right) Headphone outputs per Channel
Max. output level	140 mW at 32 ohms, 385mW at 66 ohms.
Impedance minimum	8 Ohms

Global Specifications

Frequency response	10 Hz to 32 kHz, +/- 3 dB
Noise	> 90 dB, unweighted, 22 Hz to 22 kHz
THD	0.008 % typ. @ +4 dBu, 1 kHz

Power Supply

Mains Voltages USA/Canada	105-125 VAC ~, 60 Hz
Mains Voltages Europe	215 – 254 VAC~, 50Hz
Power Inlet	Standard IEC receptacle / with fuse
Power Consumption	29 Watts Max.

Physical

Dimensions	1 3/4" (44.5 mm) * 19" (482.6 mm) * 8 1/2" (217 mm)
Net Weight	5.5lbs., (2.5 kg)
Shipping Weight	8lbs., (3.6 kg)

S•Phone Block Diagram

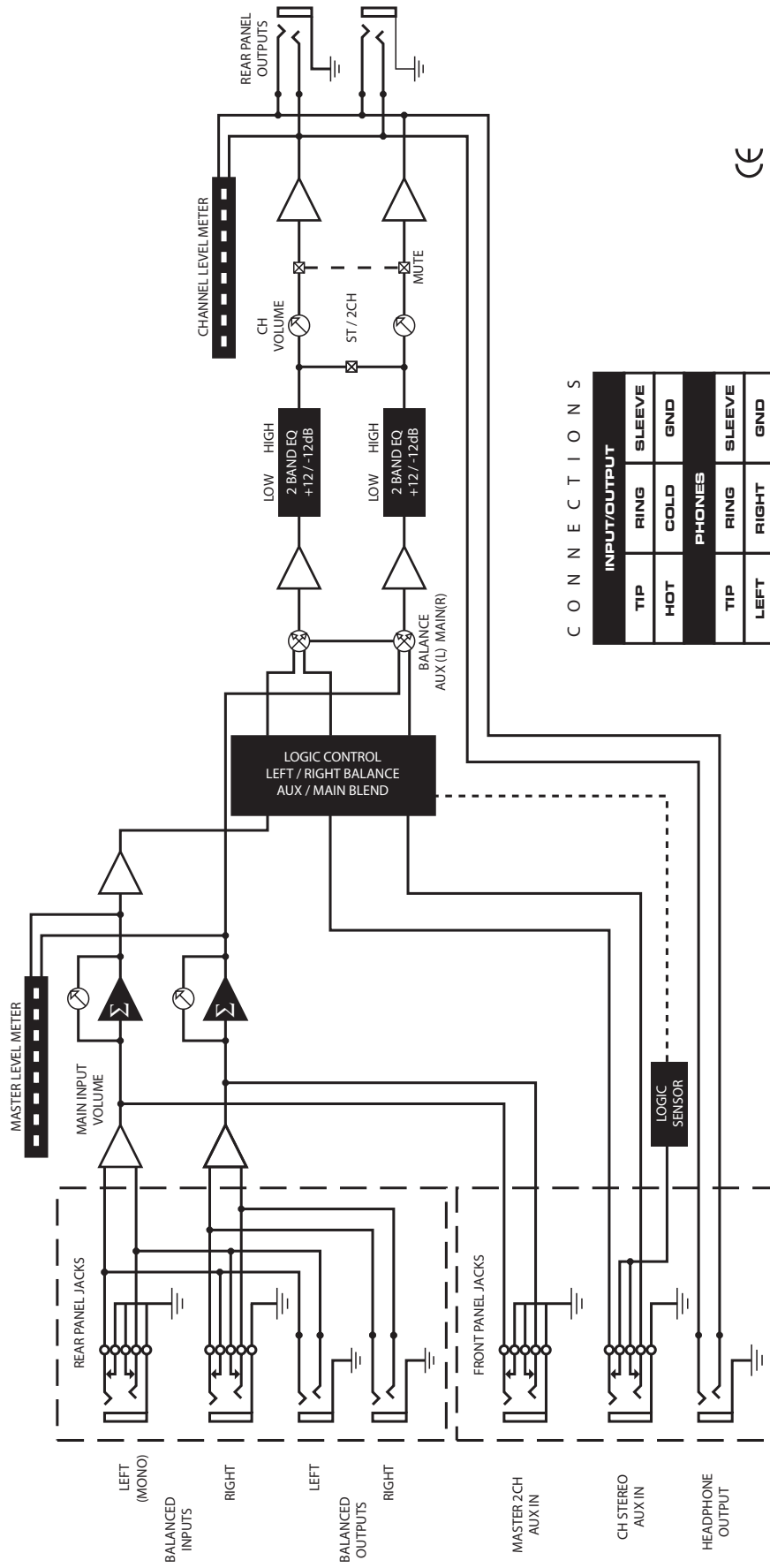

Samson Technologies Corp.
575 Underhill Blvd.
P.O. Box 9031
Syosset, NY 11791-9031
Phone: 1-800-3-SAMSON (1-800-372-6766)
Fax: 516-364-3888
www.samsontech.com